

TKA series

Chip-tight right to the end

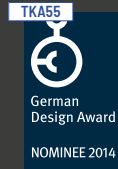

* Refers to type TKA55 with BI 50 - 175.
More information on certification can be found at:
tsubaki-kabelschlepp.com/tka-ip54

Trademarks are legally protected for the TSUBAKI KABELSCHLEPP GmbH
as a national or international registration in the following countries:
tsubaki-kabelschlepp.com/trademarks



- | | | | |
|--|---|--|---|
| <p>1 End connectors with optional strain relief</p> <p>2 Interior gentle on the cables without projecting edges</p> <p>3 Integrated noise damping</p> | <p>4 Dividers and height separations for separating the cables</p> <p>5 Quick and easy opening from any position</p> <p>6 Secure cover attachment even under severe stresses (e.g. from hydraulic lines)</p> | <p>7 Chain links made of glass-fiber reinforced plastic</p> <p>8 Bolt/hole connection and stroke system covered completely</p> <p>9 Designs with inward or outward opening cross-bars</p> | <p>10 Covers completely detachable on one side</p> <p>11 Cover sheet for universal end connectors</p> |
|--|---|--|---|

Features

- » Excellent cable protection in the connector area
- » Chip and dirt resistant due to smooth surfaces
- » Extensive unsupported length
- » High torsional rigidity
- » Low noise emission
- » Numerous custom material types for custom applications available
- » Easy-to-open cover with simultaneously high retention force on the chain link during operation
- » Measurement scale for easy alignment of the dividers
- » TKA55: IP54 tested and certified*

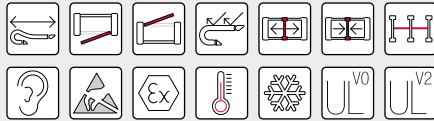

Optimized utilization of the interior space; vertical and horizontal inner distribution possible



Easy-open covers from any position offer secure fastening



Triple-stroke system for extensive unsupported length

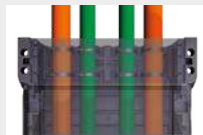

Universal end connector with option for integrating strain relief elements

PROTUM®
seriesK
seriesUNIFLEX
Advanced
seriesM
seriesXL
seriesQUANTUM®
seriesTKR
seriesTKA
seriesUAT
series

Type	Opening variant	Stay variant	h_i [mm]	h_G [mm]	B_i [mm]	B_k [mm]	B_i - grid [mm]	t [mm]	KR [mm]	Additional load ≤ [kg/m]	Cable- d_{max} [mm]
PROTUM® series											
TKA30											
		060	20.5	28.5	15 - 65	28 - 78	-	30.5	55 - 180	3	16
		080	20.5	28.5	15 - 65	28 - 78	-	30.5	55 - 180	3	16
UNIFLEX Advanced series											
TKA38											
		060	26	36	25 - 130	41 - 146	-	38.5	70 - 230	5	20
		080	26	36	25 - 130	41 - 146	-	38.5	70 - 230	5	20
M series											
TKA45											
		060	36	50	50 - 150	66 - 166	-	45.5	82 - 230	6	28.5
		080	36	50	50 - 150	66 - 166	-	45.5	82 - 230	6	28.5
XL series											
TKA55											
		060	45	64	50 - 250	70 - 270	-	55.5	100 - 300	15	36
		080	45	64	50 - 250	70 - 270	-	55.5	100 - 300	15	36
QUANTUM® series											
TKR series											
TKA series											
UAT series											

Unsupported arrangement			Gliding arrangement			Inner Distribution				Movement			Page
Travel length ≤ [m]	$v_{max} \leq [m/s]$	$a_{max} \leq [m/s^2]$	Travel length ≤ [m]	$v_{max} \leq [m/s]$	$a_{max} \leq [m/s^2]$	TS0	TS1	TS2	TS3	vertical hanging or standing	lying on the side	rotating arrangement	
3.5	10	50	80	2.5	25	•	•	-	-	•	•	-	548
3.5	10	50	80	2.5	25	•	•	-	-	•	•	-	549
<hr/>													
3.9	10	50	120	2.5	20	•	•	-	-	•	•	-	554
3.9	10	50	120	2.5	20	•	•	-	-	•	•	-	555
<hr/>													
4.7	9	45	125	3	20	•	•	-	•	•	•	-	560
4.7	9	45	125	3	20	•	•	-	•	•	•	-	561
<hr/>													
6.5	8	40	150	3	15	•	•	-	•	•	•	-	568
6.5	8	40	150	3	15	•	•	-	•	•	•	-	569

PROTUM® series

K series

UNIFLEX Advanced series

M series

XL series

QUANTUM® series

TKR series

TKA series

UAT series

TKA30



Pitch
30.5 mm



Inner height
20.5 mm



Inner widths
15 – 65 mm



Bending radii
55 – 180 mm

Stay variants



Design 060 page 548

Covered on both sides with inside detachable cover

- » Plastic cover for rough environmental conditions with dirt, chips or spray water.
- » Fully detachable on one side in any position.
- » **Inside:** very quick release.



Design 080 page 549

Covered on both sides with outside detachable cover

- » Plastic cover for rough environmental conditions with dirt, chips or spray water.
- » Fully detachable on one side in any position.
- » **Outside:** very quick release.

Unsupported arrangement

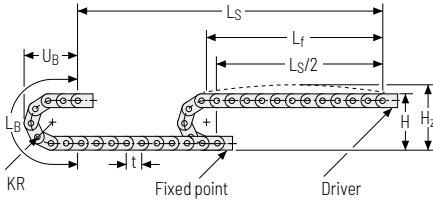





KR [mm]	H [mm]	H _z [mm]	L _B [mm]	U _B [mm]
55	139	164	234	100
75	179	204	297	120
95	219	244	359	140
125	279	304	454	170
145	319	344	516	190
180	389	414	626	225

Load diagram for unsupported length depending on the additional load.

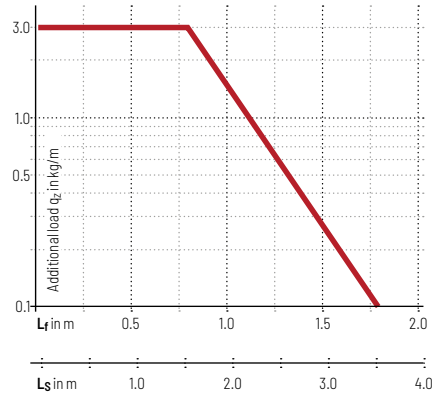
Sagging of the cable carrier is technically permitted for extended travel lengths, depending on the specific application.





Intrinsic cable carrier weight $q_k = 0.67 \text{ kg/m}$ at B; 50 mm. For other inner widths, the maximum additional load changes.

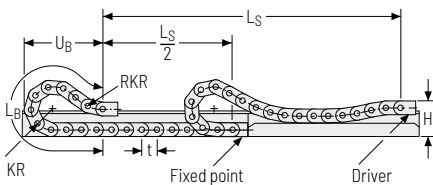

-  **Speed**
up to 10 m/s
-  **Acceleration**
up to 50 m/s²
-  **Travel length**
up to 3.5 m
-  **Additional load**
up to 3 kg/m

Gliding arrangement



-  **Speed**
up to 2.5 m/s
-  **Acceleration**
up to 25 m/s²
-  **Travel length**
up to 80 m
-  **Additional load**
up to 3 kg/m

 The gliding cable carrier has to be routed in a channel. See p. 844.

PROTUM® series
K series
UNIFLEX Advanced series
M series
XL series
QUANTUM® series
TKR series
TKA series
UAT series

Stay variant 060 – covered on both sides with inside detachable cover

- » Plastic cover for rough environmental conditions with dirt, chips or spray water.
- » Fully detachable on one side in any position.
- » **Inside:** very quick release.



Stay arrangement on each chain link (**VS: fully-stayed**)



B_i 15 – 65 mm

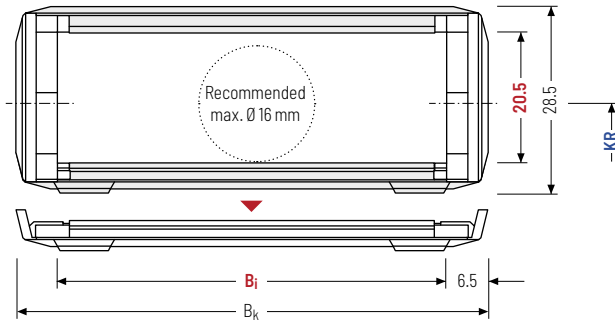

The maximum cable diameter strongly depends on the bending radius and the desired cable type. Please contact us.

Calculating the cable carrier length

Cable carrier length L_k

$$L_k \approx \frac{L_S}{2} + L_B$$

Cable carrier length L_k rounded to pitch t

h_i [mm]	h_g [mm]	B_i [mm]						B_k [mm]	KR [mm]					q_k [kg/m]	
20,5	28,5	15	20	25	38	50	65	$B_i + 13$	55	75	95	125	145	180	0,48 – 0,76

Order example



TKA30

Type

060

Stay variant

50

B_i [mm]

125

KR [mm]

915

L_k [mm]

VS

Stay arrangement

Stay variant 080 – covered on both sides with outside detachable cover

- » Plastic cover for rough environmental conditions with dirt, chips or spray water.
- » Fully detachable on one side in any position.
- » **Outside:** very quick release.



Stay arrangement on each chain link (**VS: fully-stayed**)

B_i 15 – 65 mm

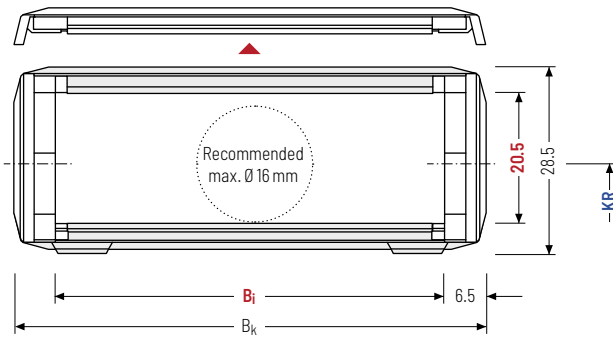

The maximum cable diameter strongly depends on the bending radius and the desired cable type. Please contact us.

Calculating the cable carrier length

Cable carrier length L_k

$$L_k \approx \frac{L_S}{2} + L_B$$

Cable carrier length L_k rounded to pitch t

h_i [mm]	h_g [mm]	B_i [mm]		B_k [mm]	KR [mm]				q_k [kg/m]						
20,5	28,5	15	20	25	38	50	65	$B_i + 13$	55	75	95	125	145	180	0.48 – 0.76

Order example

TKA30 (Type) · **080** (Stay variant) · **50** (B_i [mm]) · **125** (KR [mm]) · **915** (L_k [mm]) · **VS** (Stay arrangement)

Divider systems

As a standard, the divider system is mounted on every 2nd chain link.

As a standard, dividers, or the complete divider system (dividers with height separations) are movable in the cross section (**version A**).

The dividers are easily attached to the stay for applications with transverse accelerations and for applications laying on the side by simply turning them.

The locking cams click into place in the locking grids in the covers (**version B**).

Divider system TSO without height separation

Vers.	a _T min [mm]	a _x min [mm]	a _c min [mm]	a _x grid [mm]	η _T min
A	3.5	7	5	-	-
B	3.5	8	6	2	-

B _i [mm]	15	20	25	38	50	65
a _T min [mm]	7.5	8	8.5	9	9	8.5

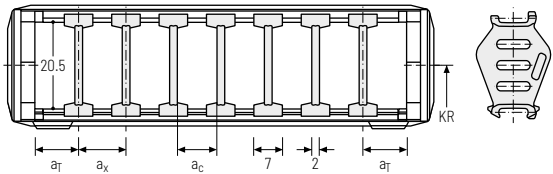

Divider system TS1 with continuous height separation

Vers.	a _T min [mm]	a _x min [mm]	a _c min [mm]	a _x grid [mm]	η _T min
A	3.5	7	5	-	2
B	3.5	8	6	2	2

B _i [mm]	15	20	25	38	50	65
a _T min [mm]	7.5	8	8.5	9	9	8.5

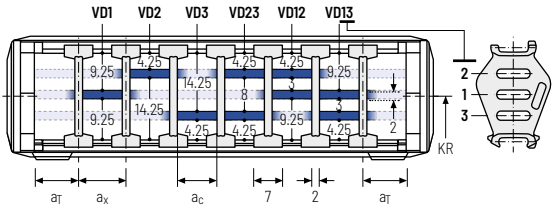

Order example



TS1	.	A	.	3	-	V00
⋮						
						V01
Divider system		Version		η _T		Height separation

Please state the designation of the divider system (**TS0, TS1...**), version and number of dividers per cross section [η_T].

If using divider systems with height separation (**TS1**) please also state the positions [e.g. VD1] viewed from the left driver belt. You are welcome to add a sketch to your order.

Universal end connectors UMB – plastic (standard)

The universal end connectors (UMB) are made from plastic and can be mounted from the top, from the bottom, or face on.

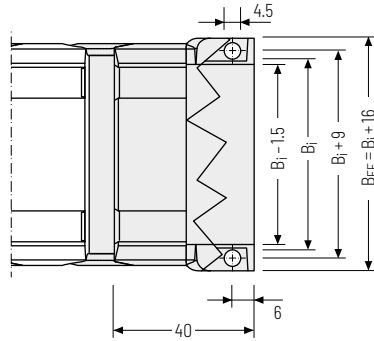
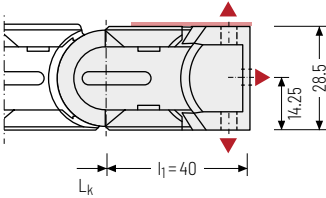

▲ Assembly options

 Recommended tightening torque: 3 Nm for cheese-head screws ISO 4762 - M4 x 12

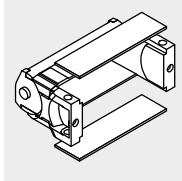
 The end connectors are also available as an option **without** cover sheets. Please state when ordering.

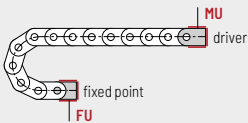

Connection point
F - fixed point
M - driver

Connection type
U - Universal mounting bracket

Order example

	UMB	F	U
	UMB	M	U
	End connector	Connection point	Connection type

 We recommend the use of strain reliefs before driver and fixed point. See from p. 904.

PROTUM® series
K series
UNIFLEX Advanced series
M series
XL series
QUANTUM® series
TKR series
TKA series
UAT series

TKA38



Pitch
38.5 mm



Inner height
26 mm



Inner widths
25 – 130 mm



Bending radii
70 – 230 mm

Stay variants



Design 060 page 554

Covered on both sides with inside detachable cover

- » Plastic cover for rough environmental conditions with dirt, chips or spray water.
- » Fully detachable on one side in any position.
- » **Inside:** very quick release.



Design 080 page 555

Covered on both sides with outside detachable cover

- » Plastic cover for rough environmental conditions with dirt, chips or spray water.
- » Fully detachable on one side in any position.
- » **Outside:** very quick release.

Unsupported arrangement

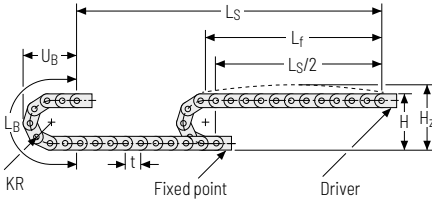





KR [mm]	H [mm]	H ₂ [mm]	L _B [mm]	U _B [mm]
70	176	201	297	127
95	226	251	375	152
120	276	301	454	177
145	326	351	532	202
170	376	401	611	227
195	426	451	689	252
230	496	521	799	287

Load diagram for unsupported length depending on the additional load.

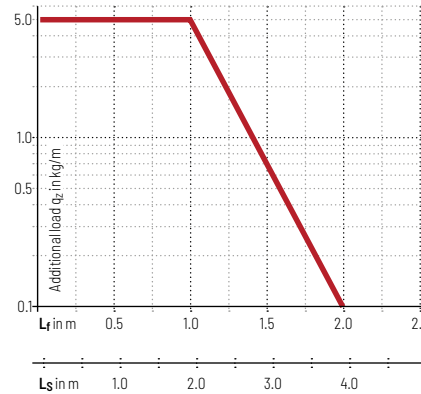
Sagging of the cable carrier is technically permitted for extended travel lengths, depending on the specific application.





Intrinsic cable carrier weight $q_k = 1.13 \text{ kg/m}$ at B_i 78 mm. For other inner widths, the maximum additional load changes.

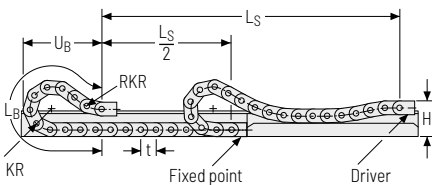

-  **Speed**
up to 10 m/s
-  **Acceleration**
up to 50 m/s²
-  **Travel length**
up to 3.9 m
-  **Additional load**
up to 5 kg/m

Gliding arrangement



-  **Speed**
up to 2.5 m/s
-  **Acceleration**
up to 20 m/s²
-  **Travel length**
up to 120 m
-  **Additional load**
up to 5 kg/m

 The gliding cable carrier has to be routed in a channel. See p. 844.

PROTUM® series
K series
UNIFLEX Advanced series
M series
XL series
QUANTUM® series
TKR series
TKA series
UAT series

Stay variant 060 – covered on both sides with inside detachable cover

- » Plastic cover for rough environmental conditions with dirt, chips or spray water.
- » Fully detachable on one side in any position.
- » **Inside:** very quick release.



Stay arrangement on each chain link (**VS: fully-stayed**)



B_i : 25 – 130 mm

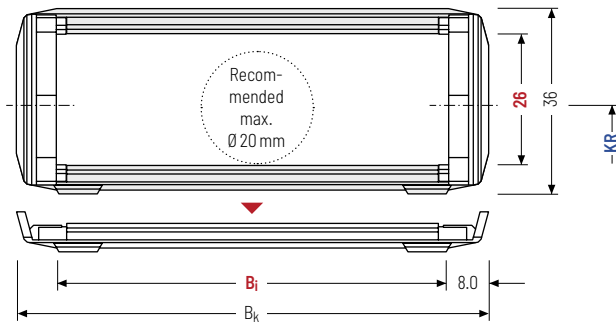

The maximum cable diameter strongly depends on the bending radius and the desired cable type. Please contact us.

Calculating the cable carrier length

Cable carrier length L_k

$$L_k \approx \frac{L_S}{2} + L_B$$

Cable carrier length L_k rounded to pitch t

h_i [mm]	h_c [mm]	B_i [mm]		B_k [mm]	KR [mm]				q_k [kg/m]							
26	36.75	25	38	58	78	103	130	$B_i + 16$	70	95	120	145	170	195	230	0.77 - 1.47

Order example



TKA38

Type

060

Stay variant

78

B_i [mm]

145

KR [mm]

1155

L_k [mm]

VS

Stay arrangement

Stay variant 080 – covered on both sides with outside detachable cover

- » Plastic cover for rough environmental conditions with dirt, chips or spray water.
- » Fully detachable on one side in any position.
- » **Outside:** very quick release.



 Stay arrangement on each chain link (**VS: fully-stayed**)

 B_i 25 – 130 mm

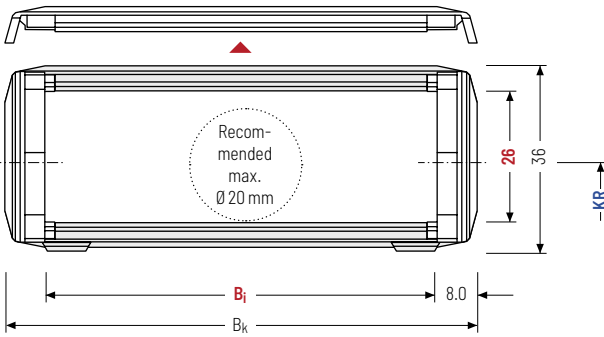

 The maximum cable diameter strongly depends on the bending radius and the desired cable type. Please contact us.

Calculating the cable carrier length

Cable carrier length L_k

$$L_k \approx \frac{L_S}{2} + L_B$$

Cable carrier length L_k rounded to pitch t

h_i [mm]	h_c [mm]	B_i [mm]							B_k [mm]	KR [mm]							q_k [kg/m]
26	36.75	25	38	58	78	103	130	$B_i + 16$	70	95	120	145	170	195	230	0.77 – 1.47	

Order example

 **TKA38** . **080** . **78** . **145** . **1155** . **VS**
 Type Stay variant B_i [mm] KR [mm] L_k [mm] Stay arrangement

Divider systems

As a standard, the divider system is mounted on every 2nd chain link.

As a standard, dividers or the complete divider system (dividers with height separations) are movable in the cross section (**version A**).

The dividers are easily attached to the stay for applications with transverse accelerations and for applications laying on the side by simply turning them.

The locking cams click into place in the locking grids in the covers (**version B**).

Divider system TSO without height separation

Vers.	a _T min [mm]	a _x min [mm]	a _c min [mm]	a _x grid [mm]	nr min
A	3.5	7	5	-	-
B	8	8	6	2	-
B_i [mm]					
	25	38	58	78	103
a_T min [mm]					
	8.5	9	9	9	7.5

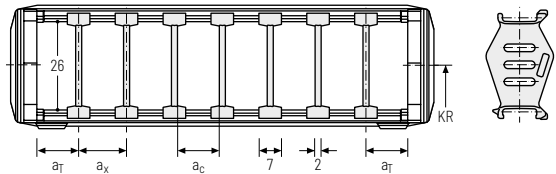

Divider system TS1 with continuous height separation

Vers.	a _T min [mm]	a _x min [mm]	a _c min [mm]	a _x grid [mm]	nr min
A	3.5	7	5	-	2
B	8	8	6	2	2
B_i [mm]					
	25	38	58	78	103
a_T min [mm]					
	8.5	9	9	9	7.5

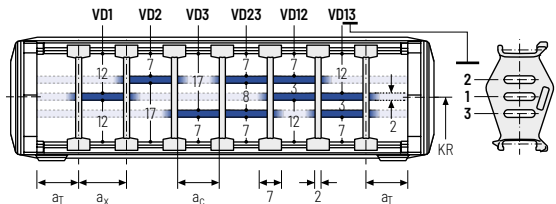

Order example



TS1	.	A	.	3	-	V00
⋮						
						V01
Divider system		Version		nr		Height separation

Please state the designation of the divider system (**TS0, TS1...**), version and number of dividers per cross section [nr].

If using divider systems with height separation (**TS1**) please also state the positions [e.g. VD1] viewed from the left driver belt. You are welcome to add a sketch to your order.

Universal end connectors UMB – plastic (standard)

The universal end connectors (UMB) are made from plastic and can be mounted from the top, from the bottom, or face on.

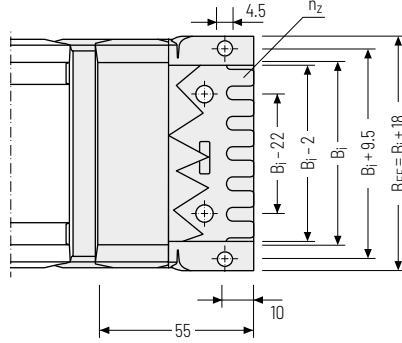
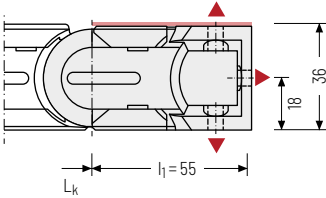

▲ Assembly options

Recommended tightening torque: 3 Nm for cheese-head screws ISO 4762 - M4 x 20

B_i [mm]	B_{EF} [mm]	n_z
25	43	2
38	56	3
58	76	5
78	96	7
103	121	9
130	148	11

The end connectors are also available as an option **without** cover sheets. Please state when ordering.

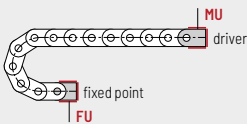

Connection point
F - fixed point
M - driver

Connection type
U - Universal mounting bracket

Order example

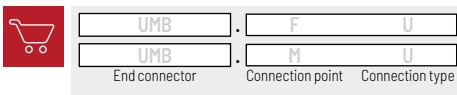

PROTUM® series
K series
UNIFLEX Advanced series
M series
XL series
QUANTUM® series
TKR series
TKA series
UAT series

TKA45



Pitch
45.5 mm



Inner height
36 mm



Inner widths
50 – 150 mm



Bending radii
82 – 230 mm

Stay variants



Design 060 page **560**

Covered on both sides with inside detachable cover

- » Plastic cover for rough environmental conditions with dirt, chips or spray water.
- » Fully detachable on one side in any position.
- » **Inside:** very quick release.



Design 080 page **561**

Covered on both sides with outside detachable cover

- » Plastic cover for rough environmental conditions with dirt, chips or spray water.
- » Fully detachable on one side in any position.
- » **Outside:** very quick release.

Unsupported arrangement

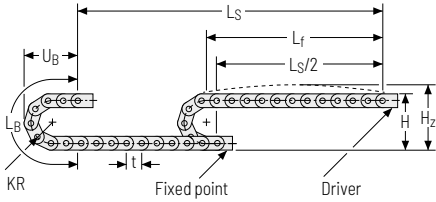

KR [mm]	H [mm]	H _z [mm]	L _B [mm]	U _B [mm]
82	214	249	348	153
95	240	275	389	166
125	300	335	483	196
145	340	375	546	216
170	390	425	625	241
200	450	485	719	271
230	520	555	814	301

Load diagram for unsupported length depending on the additional load.

Sagging of the cable carrier is technically permitted for extended travel lengths, depending on the specific application.

Intrinsic cable carrier weight $q_k = 2.29 \text{ kg/m}$ at B_i 150 mm. For other inner widths, the maximum additional load changes.

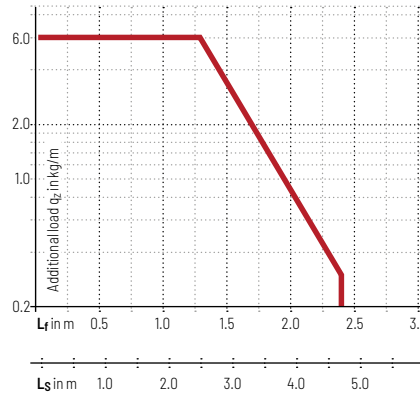

Speed
up to 9 m/s

Acceleration
up to 45 m/s²

Travel length
up to 4.7 m

Additional load
up to 6 kg/m

Gliding arrangement

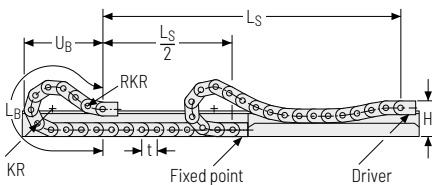

Speed
up to 3 m/s

Acceleration
up to 20 m/s²

Travel length
up to 125 m

Additional load
up to 6 kg/m

 The gliding cable carrier has to be routed in a channel. See p. 844.

Stay variant 060 – covered on both sides with inside detachable cover

- » Plastic cover for rough environmental conditions with dirt, chips or spray water.
- » Fully detachable on one side in any position.
- » **Inside:** very quick release.



Stay arrangement on each chain link (**VS: fully-stayed**)



B_i : 50 – 150 mm

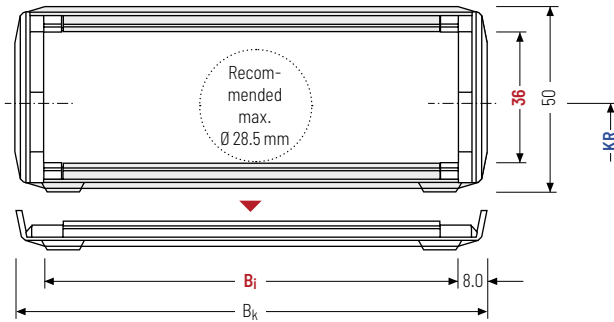

The maximum cable diameter strongly depends on the bending radius and the desired cable type. Please contact us.

Calculating the cable carrier length

Cable carrier length L_k

$$L_k \approx \frac{L_S}{2} + L_B$$

Cable carrier length L_k
rounded to pitch t

h_i [mm]	h_G [mm]	B_i [mm]			B_k [mm]	KR [mm]					q_k [kg/m]				
36	51	50	75	100	125	150	$B_i + 16$	82	95	125	145	170	200	230	1.34 – 2.29

Order example

	TKA45 Type	·	060 Stay variant	·	125 B_i [mm]	·	170 KR [mm]	·	1456 L_k [mm]	·	VS Stay arrangement
--	---------------	---	---------------------	---	-------------------	---	----------------	---	--------------------	---	------------------------

Stay variant 080 – covered on both sides with outside detachable cover

- » Plastic cover for rough environmental conditions with dirt, chips or spray water.
- » Fully detachable on one side in any position.
- » **Outside:** very quick release.



Stay arrangement on each chain link (**VS: fully-stayed**)

B_k 50 – 150 mm

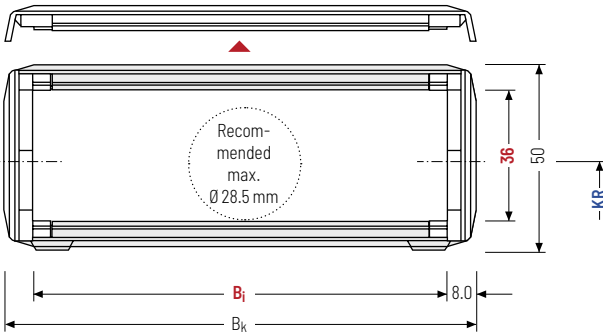

The maximum cable diameter strongly depends on the bending radius and the desired cable type. Please contact us.

Calculating the cable carrier length

Cable carrier length L_k

$$L_k \approx \frac{L_S}{2} + L_B$$

Cable carrier length L_k rounded to pitch t

h _i [mm]	h _g [mm]	B _i [mm]			B _k [mm]	KR [mm]					q _k [kg/m]				
36	51	50	75	100	125	150	B _i + 16	82	95	125	145	170	200	230	1.34 - 2.29

Order example

TKA45 · **080** · **125** · **170** · **1456** · **VS**
 Type · Stay variant · B_i [mm] · KR [mm] · L_k [mm] · Stay arrangement

PROTUM® series

K series

UNIFLEX Advanced series

M series

XL series

QUANTUM® series

TKR series

TKA series

UAT series

Divider systems

The divider system is mounted on every 2nd chain link as a standard.

As a standard, dividers or the complete divider system (dividers with height separations) are movable in the cross section (**version A**).

The dividers are easily attached to the stay for applications with transverse accelerations and for applications laying on the side by simply turning them.

The locking cams click into place in the locking grids in the covers (**version B**).

Divider system TSO without height separation

Vers.	a _T min [mm]	a _x min [mm]	a _c min [mm]	a _x grid [mm]	η _T min
A	4	8	5.5	-	-
B	↑	8	5.5	2	-

B _i [mm]	50	75	100	125	150
a _T min [mm]	11	11.5	12	12.5	11

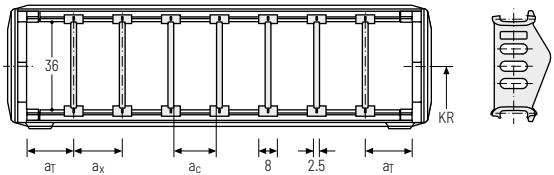

Divider system TS1 with continuous height separation

Vers.	a _T min [mm]	a _x min [mm]	a _c min [mm]	a _x grid [mm]	η _T min
A	4	8	5.5	-	2
B	↑	8	5.5	2	2

B _i [mm]	50	75	100	125	150
a _T min [mm]	11	11.5	12	12.5	11

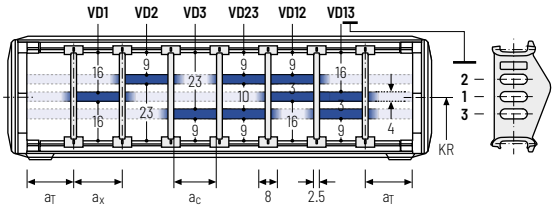

Order example



TS1	.	A	.	3	-	V00
						⋮
						V01
Divider system		Version		η _T		Height separation

Please state the designation of the divider system (**TS0, TS1...**), version and number of dividers per cross section [η_T].

If using divider systems with height separation (**TS1**) please also state the positions [e.g. VD1] viewed from the left driver belt. You are welcome to add a sketch to your order.

Divider system TS3 with height separation consisting of plastic partitions

As a standard, the divider **A** is used for vertical partitioning within the cable carrier. The complete divider system can be moved within the cross section. (**version A**).

The dividers are easily attached to the stay for applications with transverse accelerations and for applications laying on the side by simply turning them. The locking cams click into place in the locking grids in the covers (**version B**).

Divider version A

End divider



Vers.	a _T min [mm]	a _x min [mm]	a _c min [mm]	n _T min
A	4/2*	14	10	2

* For End divider

The dividers are fixed by the partitions. the complete divider system is movable in the cross section.

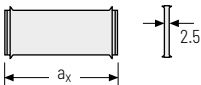
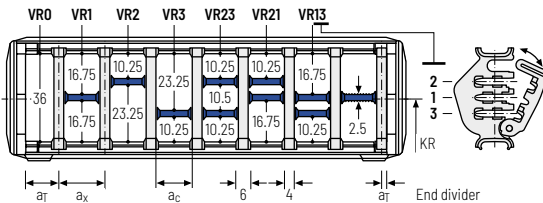

a _x (center distance of dividers) [mm]																
a _c (nominal width of inner chamber) [mm]																
14	16	19	23	24	28	29	32	33	34	38	39	43	44	48	49	54
10	12	15	19	20	24	25	28	29	30	34	35	39	40	44	45	50
58	59	64	68	69	74	78	79	80	84	88	89	94	96	99	112	
54	55	60	64	65	70	74	75	76	80	84	85	90	92	95	108	

When using partitions with a_x > 49 mm we recommended an additional preferential central support.

Order example

TS3

A

3

K1

34

VR1

⋮
 ⋮
 ⋮

K4

38

VR3

Divider system Version n_T Chamber a_x Height separation

Please state the designation of the divider system (**TS0, TS1...**), version and number of dividers per cross section [n_T]. In addition, please also enter the chambers [K] from left to right, as well as the assembly distances [a_T/a_x] (as seen from the driver).

If using divider systems with height separation (**TS1, TS3**) please also state the positions [e.g. VD23] viewed from the left driver belt. You are welcome to add a sketch to your order.

PROTUM® series
K series
UNIFLEX Advanced series
M series
XL series
QUANTUM® series
TKR series
TKA series
UAT series

UAT
series

TKA
series

TKR
series

QUANTUM®
series

XL
series

M
series

UNIFLEX
Advanced
series

K
series

PROTUM®
series



Universal end connectors UMB – plastic (standard)

The universal end connectors (UMB) are made from plastic and can be mounted from the top, from the bottom, or face on.

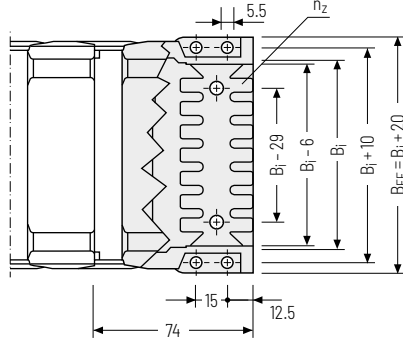
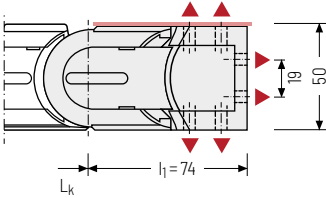

▲ Assembly options

Recommended tightening torque: 5 Nm for cheese-head screws ISO 4762 - M5 x 8.8

B_i [mm]	B_{EF} [mm]	n_z
50	70	2 x 3
75	95	2 x 5
100	120	2 x 7
125	145	2 x 9
150	170	2 x 11

The end connectors are also available as an option **without** cover sheets. Please state when ordering.

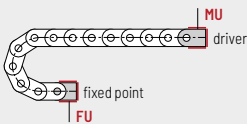

Connection point
F - fixed point
M - driver

Connection type
U - Universal mounting bracket

Order example

	UMB	.	F	U
	UMB	.	M	U
	End connector		Connection point	Connection type

PROTUM® series
K series
UNIFLEX Advanced series
M series
XL series
QUANTUM® series
TKR series
TKA series
UAT series

TKA55



Pitch
55.5 mm



Inner height
45 mm



Inner widths
50 – 250 mm



Bending radii
100 – 300 mm

Stay variants



Design 060 page **568**

Covered on both sides with inside detachable cover

- » Plastic cover for rough environmental conditions with dirt, chips or spray water.
- » Fully detachable on one side in any position.
- » **Inside:** very quick release.



Design 080 page **569**

Covered on both sides with outside detachable cover

- » Plastic cover for rough environmental conditions with dirt, chips or spray water.
- » Fully detachable on one side in any position.
- » **Outside:** very quick release.

Unsupported arrangement

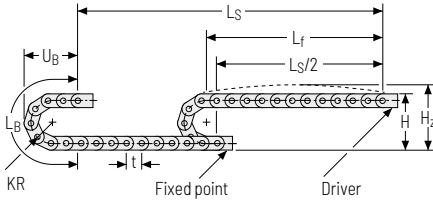

KR [mm]	H [mm]	H _z [mm]	L _B [mm]	U _B [mm]
100	264	304	425	188
120	304	344	488	208
140	344	384	551	228
170	404	454	645	258
195	454	494	725	283
225	514	554	818	313
250	564	604	896	338
300	664	704	1211	388

Load diagram for unsupported length depending on the additional load.

Sagging of the cable carrier is technically permitted for extended travel lengths, depending on the specific application.

Intrinsic cable carrier weight $q_k = 1.95 \text{ kg/m}$ at B_i 50 mm. For other inner widths, the maximum additional load changes.

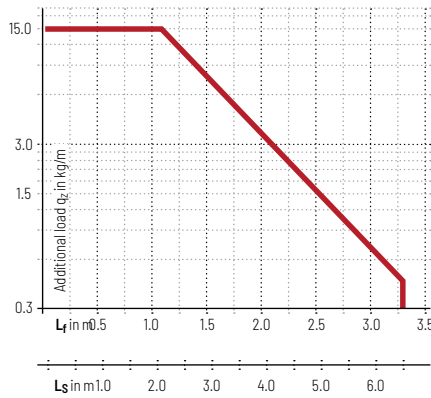

Speed
up to 8 m/s

Acceleration
up to 40 m/s²

Travel length
up to 6.5 m

Additional load
up to 15 kg/m

Gliding arrangement

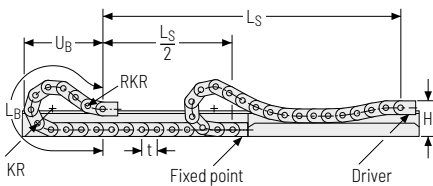

Speed
up to 3 m/s

Acceleration
up to 15 m/s²

Travel length
up to 150 m

Additional load
up to 15 kg/m

The gliding cable carrier has to be routed in a channel. See p. 844.

PROTUM® series

K series

UNIFLEX Advanced series

M series

XL series

QUANTUM® series

TKR series

TKA series

UAT series

Stay variant 060 – covered on both sides with inside detachable cover

- » Plastic cover for rough environmental conditions with dirt, chips or spray water.
- » Fully detachable on one side in any position.
- » **Inside:** very quick release.



Stay arrangement on each chain link (**VS: fully-stayed**)



B_i : 50 – 250 mm

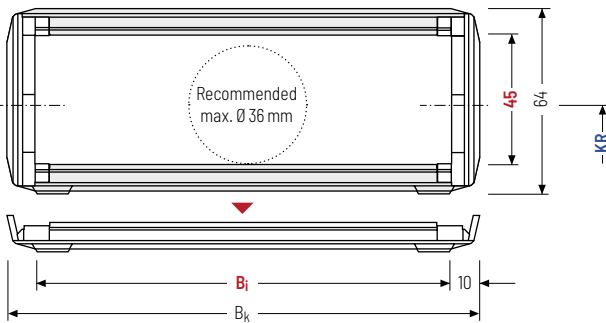

The maximum cable diameter strongly depends on the bending radius and the desired cable type. Please contact us.

Calculating the cable carrier length

Cable carrier length L_k

$$L_k \approx \frac{L_S}{2} + L_B$$

Cable carrier length L_k rounded to pitch t

h_i [mm]	h_g [mm]	B_i [mm]					B_k [mm]	KR [mm]				q_k [kg/m]
45	65	50	75	100	125	150	$B_i + 20$	100	120	140	170	1,95
		175	200	225	250	195		225	250	300	4,28	

Order example



TKA55

Type

060

Stay variant

200

B_i [mm]

225

KR [mm]

2553

L_k [mm]

VS

Stay arrangement

Stay variant 080 – covered on both sides with outside detachable cover

- » Plastic cover for rough environmental conditions with dirt, chips or spray water.
- » Fully detachable on one side in any position.
- » **Outside:** very quick release.



 Stay arrangement on each chain link (**VS: fully-stayed**)

 B_i : 50 – 150 mm

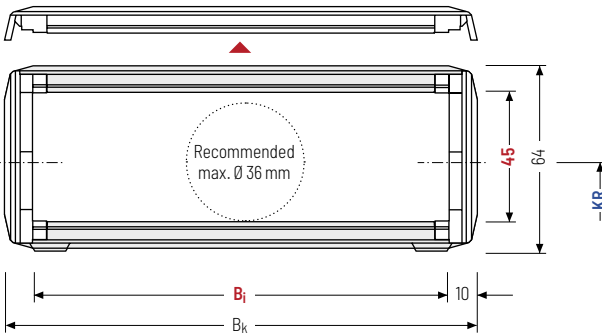

 The maximum cable diameter strongly depends on the bending radius and the desired cable type. Please contact us.

Calculating the cable carrier length

Cable carrier length L_k

$$L_k \approx \frac{L_S}{2} + L_B$$

Cable carrier length L_k rounded to pitch t

h_i [mm]	h_g [mm]	B_i [mm]					B_k [mm]	KR [mm]				q_k [kg/m]
45	65	50	75	100	125	150	$B_i + 20$	100	120	140	170	1,95
		175	200	225	250	195		225	250	300	4,28	

Order example

 **TKA55** . **080** . **200** . **225** . **2553** . **VS**
 Type Stay variant B_i [mm] KR [mm] L_k [mm] Stay arrangement

Divider systems

As a standard, the divider system is mounted on every 2nd chain link.

As a standard, dividers or the complete divider system (dividers with height separations) are movable in the cross section (**version A**).

The dividers are easily attached to the stay for applications with transverse accelerations and for applications laying on the side by simply turning them.

The locking cams click into place in the locking grids in the covers (**version B**).

Divider system TSO without height separation

Vers.	a _T min [mm]	a _X min [mm]	a _C min [mm]	a _X grid [mm]	η _T min
A	5	10	7	-	-
B	10	10	7	2	-

B _i [mm]	50	75	100	125	150
a _T min [mm]	13	11.5	12	12.5	13
B _i [mm]	175	200	225	250	
a _T min [mm]	11.5	12	12.5	13	

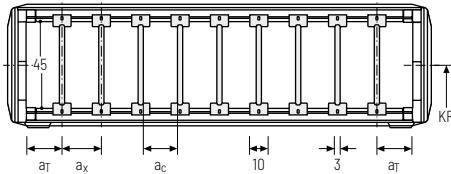

Divider system TS1 with continuous height separation

Vers.	a _T min [mm]	a _X min [mm]	a _C min [mm]	a _X grid [mm]	η _T min
A	5	10	7	-	2
B	10	10	7	2	2

B _i [mm]	50	75	100	125	150
a _T min [mm]	13	11.5	12	12.5	13
B _i [mm]	175	200	225	250	
a _T min [mm]	11.5	12	12.5	13	

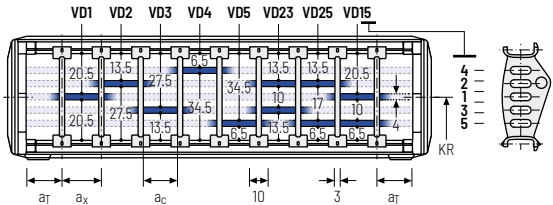

Order example



TS1	.	A	.	3	-	V00
						⋮
						V01
Divider system		Version		η _T		Height separation

Please state the designation of the divider system (**TS0, TS1...**), version and number of dividers per cross section [η_T].

If using divider systems with height separation (**TS1**) please also state the positions [e.g. VD1] viewed from the left driver belt. You are welcome to add a sketch to your order.

Divider system TS3 with height separation consisting of plastic partitions

As a standard, the divider **A** is used for vertical partitioning within the cable carrier. The complete divider system can be moved within the cross section. (**version A**).

The dividers are easily attached to the stay for applications with transverse accelerations and for applications laying on the side by simply turning them. The locking cams click into place in the locking grids in the covers (**version B**).

Divider version A

End divider

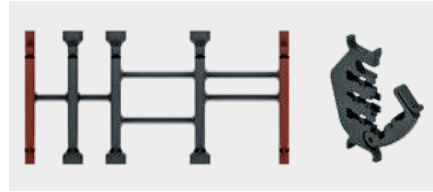

Vers.	a _T min [mm]	a _x min [mm]	a _c min [mm]	n _T min
A	4 / 2*	14	10	2

* For End divider

The dividers are fixed by the partitions. the complete divider system is movable in the cross section.

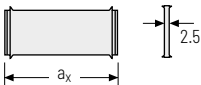
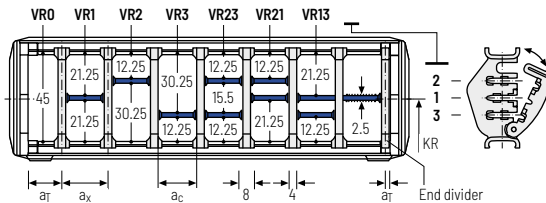

a _x (center distance of dividers) [mm]																
a _c (nominal width of inner chamber) [mm]																
14	16	19	23	24	28	29	32	33	34	38	39	43	44	48	49	54
10	12	15	19	20	24	25	28	29	30	34	35	39	40	44	45	50
58	59	64	68	69	74	78	79	80	84	88	89	94	96	99	112	
54	55	60	64	65	70	74	75	76	80	84	85	90	92	95	108	

When using partitions with a_x > 49 mm we recommend an additional preferential central support.

Order example

TS3

A

3

K1

34

VR1

:
:

K4

38

VR3

Divider system Version n_T Chamber a_x Height separation

Please state the designation of the divider system (**TS0, TS1...**). version and number of dividers per cross section [n_T]. In addition, please also enter the chambers [K] from left to right, as well as the assembly distances [a_T/a_x] (as seen from the driver).

If using divider systems with height separation (**TS1, TS3**) please also state the positions [e.g. VD23] viewed from the left driver belt. You are welcome to add a sketch to your order.

PROTUM® series
K series
UNIFLEX Advanced series
M series
XL series
QUANTUM® series
TKR series
TKA series
UAT series

UAT
seriesTKA
seriesTKR
seriesQUANTUM®
seriesXL
seriesM
seriesUNIFLEX
Advanced
seriesK
seriesPROTUM®
series

Universal end connectors UMB – plastic (standard)

The universal end connectors (UMB) are made from plastic and can be mounted from the top, from the bottom, or face on.

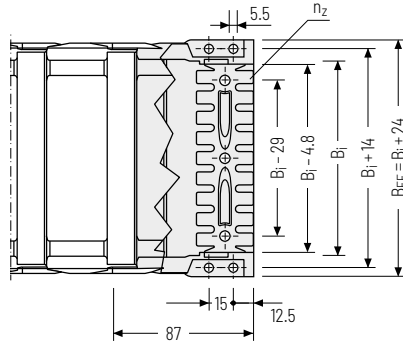
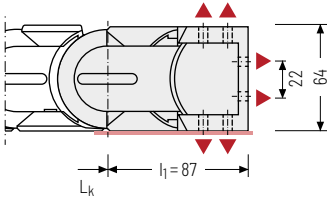

▲ Assembly options

Recommended tightening torque: 5 Nm for cheese-head screws ISO 4762 - M5 x 8.8

B_i [mm]	B_{EF} [mm]	n_z
50	74	2 x 3
75	99	2 x 5
100	124	2 x 7
125	149	2 x 9
150	174	2 x 11
175	199	2 x 13
200	224	-
225	249	-
250	274	-

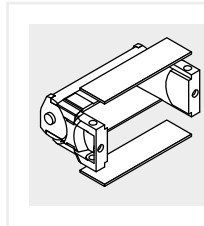

The end connectors are also available as an option **without** cover sheets. Please state when ordering.

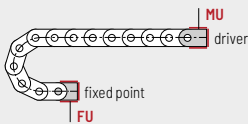

Connection point
F - fixed point
M - driver

Connection type
U - Universal mounting bracket

Order example

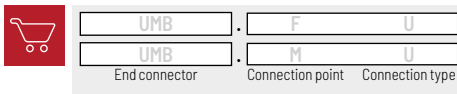

PROTUM® series
K series
UNIFLEX Advanced series
M series
XL series
QUANTUM® series
TKR series
TKA series
UAT series